

TRACTION - SW SUPERVISOR and SW VALIDATION & SIMULATION

## 20220928\_TRACTION\_02

### Background

As the world of industry 4.0 and the Internet of Things moves into the rail sector more on-line condition based monitoring is being deployed on the trains. The latest controllers are being developed with the capability to host web pages which can be accessed remotely.

### Problem description and goals

The purpose of this project is demonstrating a condition based monitoring solution for the train traction converter. The concept is to have a centralised web page which collects data from a number of end nodes and then makes this available for viewing. The kind of information includes operational status of controllers and contactors, temperatures, voltages, and energy usage in different parts of the system. The work can be split up into parts:

1. Architecture to show how to collect data over the ethernet and then present this data in a web page.
2. How to present the data in the most pedagogic and meaningful way.
3. Demonstrate a proof of concept.

### Type of degree project (can be both)    Language for the thesis

Master (20 weeks):

Swedish:  and/or English:

Bachelor/Högskoleingenjör (10 weeks):

### Is Swedish a language requirement?

Yes:

No:

No, but Swedish is a requirement for future employment:

### Possibility to work from our office

Yes:

No:

### Contact person

Name:        **Ian Bird**        Role: Traction Control SW Architect

Email: ian.bird-radolovic@alstomgroup.com

## Propulsion system digital twin linking test with simulation data

Alstom Västerås / Traction Systems - 20211108\_TRACTION\_02

### Background

The first step in the design of an electric railway propulsion system for a given application is to define the performance by means simulations. The simulations use physics-based models to determine voltages, currents and temperatures in the various components of the system. In addition to the operational data, key component parameters are also fed into the simulation. These parameters are usually the type or maximum/minimum values for each component in question. When the actual system is built it normally undergoes type testing in a lab environment and compared to the simulations. However, the individual characteristics of the installed components are not necessarily the same as the typical values. This deviation accounts for some of the differences in simulated vs tested equipment. When entering series production and delivery the variance is even more evident. A digital shadow or twin could therefore be a means to quantify the variance.

### Problem description and goals

The thesis project will focus on developing a digital twin for part of the propulsion system, e.g. the converter:

1. General study of electric traction systems
2. Study of Alstom's performance simulation tools and models
3. State of the art literature study on digital twin approaches for electric propulsion systems
4. Develop a digital twin for the selected part of the propulsion system
5. Prepare training data and evaluate digital twin
6. Analysis, conclusions and reporting

Prerequisites: Background in electrical power engineering, power electronics and electric machines combined with data science and modelling. Good analytical skills and systems thinking mindset.

### Type of degree project (can be both)    Language for the thesis

Master (20 weeks):

Swedish:  and/or English:

Bachelor/Högskoleingenjör (10 weeks):

### Is Swedish a language requirement?

Yes:

No:

No, but Swedish is a requirement for future employment:

### Possibility to work from our office

Yes:

No:

**Contact person**

Name: **Ganesh Chandramouli** Role: Head of Innovation

Email: ganesh.chandramouli@alstomgroup.com

# Propulsion performance optimization by increased utilization of SiC MOSFETs

Alstom Västerås / Traction Systems - 20211108\_TRACTION\_03

## Background

The advent of Wide Band Gap power semiconductors, especially Silicon Carbide MOSFETs, has a significant impact in creating more compact, low weight and energy efficient railway electric propulsion systems. One parameter that has not been investigated very deeply is how the theoretically increased Safe Operating Area of these devices relative to their rated current can be used to generate further system level benefits.

## Problem description and goals

The thesis project will focus on studying the impact on system level performance of higher SiC MOSFET currents and comprise the following key tasks:

1. Study of electric traction system design
2. State of the art literature study on SiC power semiconductor applications
3. Training in Alstom performance simulation tools and familiarization with Alstom's latest product range
4. Survey of optimization strategies with SiC devices
5. Definition of simulation cases
6. Performance simulations
7. Analysis, conclusions and reporting

Prerequisites: Background in electrical power engineering, power electronics and electric machines. Good analytical skills and systems thinking mindset.

## Type of degree project (can be both)    Language for the thesis

Master (20 weeks):

Swedish:  and/or English:

Bachelor/Högskoleingenjör (10 weeks):

## Is Swedish a language requirement?

Yes:

No:

No, but Swedish is a requirement for future employment:

## Possibility to work from our office

Yes:

No:

**Contact person**

Name: **Ganesh Chandramouli** Role: Head of Innovation

Email: [ganesh.chandramouli@alstomgroup.com](mailto:ganesh.chandramouli@alstomgroup.com)

## Motor Cooling Optimisation

### Alstom Västerås / Drives - 20220928\_DRIVES\_01

#### Background

What can railway traction motors learn from the emerging electromobility sector in terms of performance density?

#### Problem description and goals

- Literature review – what can railway traction motors learn from the emerging electromobility sector in terms of performance density?
- Case studies to be completed using 2D finite element modelling and optimisation techniques:
  - Identification of an optimum cooling channel configuration.
  - Assessing the impact of manufacturing tolerances on cooling channel efficiency.
  - Design optimisation of cooling channels for stress and heat transfer.
  - The impact of moving the cooling channels to the stator stack. .

#### Type of degree project (can be both)

Master (20 weeks):

Bachelor/Högskoleingenjör (10 weeks):

#### Language for the thesis

Swedish:  and/or English:

#### Is Swedish a language requirement?

Yes:

No:

No, but Swedish is a requirement for future employment:

#### Possibility to work from our office

Yes:

No:

#### Contact person

Name: **Richard Russell-Johnson** Role: Traction Motor Structural Engineer

Email: richard.russell-johnson@alstomgroup.com

## Trends from E-Mobility applied on railway Traction Motor applications

Alstom Västerås / Drives - 20220928\_DRIVES\_02

### Background

The world of electric machines gets very much attention as electric machines are essential in order to electrify the transport sector. The global trend is to implement electrical cars, buses, trucks, aircrafts, boats etc, where all relies on performance dense electric motors.

### Problem description and goals

The task of this thesis can be to:- Understand current state of railway traction motors - Pinpoint critical development areas required for success of traction motors in E-Mobility (E-aircrafts, E-trucks, E-cars etc)- Identify areas of improvements for railway traction motors, considering research applicable from the other E-mobility areas. Define how to verify in Railway application ?

Depending on profile of candidate, extended analysis can be performed in the candidate's preferred field

### Type of degree project (can be both)

Master (20 weeks):

Bachelor/Högskoleingenjör (10 weeks):

### Language for the thesis

Swedish:  and/or English:

### Is Swedish a language requirement?

Yes:

No:

No, but Swedish is a requirement for future employment:

### Possibility to work from our office

Yes:

No:

### Contact person

Name: **Tobias Nässén**

Role: Traction Motor R&D Program Manager

Email: tobias.nassen@alstomgroup.com

## Cooling enhancement technologies for enclosed traction motors

Alstom Västerås / Drives - 20220928\_DRIVES\_03

### Background

Totally enclosed traction motors normally have difficulties to dissipate heat due to poor cooling. To improve performance of such motors, it is essential to have superior cooling and superior heat transfer within the motor.

### Problem description and goals

The task of this thesis can be to:

- General study of totally enclosed traction motors for railway
- Create an understanding of loss distribution inside the motor and associated cooling paths where heat is dissipated
- Perform study on heat transfer mechanisms
- Identify and evaluate cooling enhancement technologies for enclosed traction motors
- Analysis, conclusions, reporting

### Type of degree project (can be both)

Master (20 weeks):

Bachelor/Högskoleingenjör (10 weeks):

### Language for the thesis

Swedish:  and/or English:

### Is Swedish a language requirement?

Yes:

No:

No, but Swedish is a requirement for future employment:

### Possibility to work from our office

Yes:

No:

### Contact person

Name: **Tobias Nässén**

Role: Traction Motor R&D Program Manager

Email: tobias.nassen@alstomgroup.com



## Design for recycling of traction motor

Alstom Västerås / Drives - 20220928\_DRIVES\_04

### Background

A critical topic for traction motors is that some of the alloys used in the motor are quite costly since the world market demand is very high and there are a limited numbers of suppliers of the alloys..

### Problem description and goals

The task of this thesis can be to investigate:

- How are motors in general recycled today, both within the railway industry and other areas as the automotive industry
- What alloys are recycled today and to what level can they be recycled
- How big is the difference in cost between recycled and virgin alloys
- Are there any alloys that are more or less suitable for recycling
- Are there any quality issues to use recycled alloys?

The thesis should also cover a proposal how recycling should be used in an optimal way for a Alstom Traction motor.

### Type of degree project (can be both)    Language for the thesis

Master (20 weeks):

Swedish:  and/or English:

Bachelor/Högskoleingenjör (10 weeks):

### Is Swedish a language requirement?

Yes:

No:

No, but Swedish is a requirement for future employment:

### Possibility to work from our office

Yes:

No:

### Contact person

Name: Karl-Gustav von Der Burg    Role: Product Manager, Drives

Email: karl-gustav.von-der-burg@alstomgroup.com

## Digitalisation in Modern SW Delivery Project Processes

### Alstom Västerås / Traction Control - 20220928\_TRACTION\_01

#### Background

In a fast moving and competitive market there is a never ending pressure to deliver SW projects to customers faster, but still maintain the highest quality and staying within the budget constraints. Our experience is that many projects can be delayed or go over budget due to the fact that the delivery process does not run as smoothly as first predicted. We would like to understand more detail about why this is occurring and to suggest ways to avoid or mitigate this using modern digitalisation techniques.

#### Problem description and goals

The purpose of this work is to investigate the process for delivering Propulsion SW to Alstom trains , identify where the bottlenecks are and to suggest where digitalisation could be used to optimise or improve the processes. Examples might include automation of time intensive tasks, better sharing of information or information management, simulation/digital twins to left shift design work, using AI to replace some activities which are being done by people today etc. This work will provide an introduction into the SW delivery process for a large industrial project. It will introduce the student into the 'V' model of working (Requirements to design, to testing, to verification and validation). These kinds of processes can be found in almost all industrial settings and so it will provide a valuable and transferable overview of how SW is developed. The work can be split up into 3 parts:

1. Interview engineers to build up a picture of the SW delivery process and to identify pain points and bottlenecks.
2. Review and suggest different digitisation solutions which can be applied to streamline the process and remove bottlenecks and pain points.
3. Demonstrate one or more solutions in a proof of concept

#### Type of degree project (can be both)

Master (20 weeks):

Bachelor/Högskoleingenjör (10 weeks):

#### Language for the thesis

Swedish:  and/or English:

#### Is Swedish a language requirement?

Yes:

No:

No, but Swedish is a requirement for future employment:

#### Possibility to work from our office

Yes:

No:

**Contact person**

Name: **Ian Bird** Role: Traction Control SW Architect

Email: [ian.bird-radolovic@alstomgroup.com](mailto:ian.bird-radolovic@alstomgroup.com)

## SW SUPERVISOR and SW VALIDATION & SIMULATION

### Alstom Västerås / Traction Control - 20220928\_TRACTION\_02

#### Background

As the world of industry 4.0 and the Internet of Things moves into the rail sector more on-line condition based monitoring is being deployed on the trains. The latest controllers are being developed with the capability to host web pages which can be accessed remotely.

#### Problem description and goals

The purpose of this project is demonstrating a condition based monitoring solution for the train traction converter. The concept is to have a centralised web page which collects data from a number of end nodes and then makes this available for viewing. The kind of information includes operational status of controllers and contactors, temperatures, voltages, and energy usage in different parts of the system. The work can be split up into parts:

1. Architecture to show how to collect data over the ethernet and then present this data in a web page.
2. How to present the data in the most pedagogic and meaningful way.
3. Demonstrate a proof of concept.

**Type of degree project (can be both)**    **Language for the thesis**  
Master (20 weeks):                       Swedish:  and/or English:   
Bachelor/Högskoleingenjör (10 weeks):

#### Is Swedish a language requirement?

Yes:

No:

No, but Swedish is a requirement for future employment:

#### Possibility to work from our office

Yes:

No:

#### Contact person

Name:        **Ian Bird**        Role: Traction Control SW Architect  
Email: [ian.bird-radolovic@alstomgroup.com](mailto:ian.bird-radolovic@alstomgroup.com)

# Examensarbete – teknisk utredning om detektering av moderna signallampor

**Alstom Stockholm**

## **Background**

När lågenergilampor gör inträde inom järnvägssignallering, så måste signalsystemen anpassas. Problemen måste kartläggas i förväg. Förbättringar måste föreslås.

## **Problem description and goals**

Glödtrådsbaserade signallampor dominerar fortfarande inom järnvägen. Att gå över till modern lamptechnik kommer innebära vissa utmaningar. Den s.k. ATP kodaren som tillverkas och säljs av Alstom sen många år tillbaka gör effektmätningar på signallampor och är så anpassad till uppgiften att den inte kan hantera moderna lampor. Detta behöver lösas.

Arbetet är teoretiskt och praktiskt.

Se även arbetsinstruktion 1DOC-1090352

## **Type of degree project (can be both)**

Master (20 weeks):

Bachelor/Högskoleingenjör (10 weeks):

## **Language for the thesis**

Swedish:  and/or English:

## **Is Swedish a language requirement?**

Yes:

No:

No, but Swedish is a requirement for future employment:

## **Possibility to work from our office**

Yes:

No:

## **Contact person**

Name: Fredrik Täng

Role: Produktägare

Email: fredrik.tang@alstomgroup.com

# Evaluation of open-source hypervisors for safety critical railway applications

## ALSTOM

### Background

Leading societies to a low carbon future, Alstom develops and markets mobility solutions that provide the sustainable foundations for the future of transportation. Our product portfolio ranges from high-speed trains, metros, monorail, and trams to integrated systems, customised services, infrastructure, signalling and digital mobility solutions. Joining us means joining a caring, responsible, and innovative company where more than 70,000 people lead the way to greener and smarter mobility, worldwide.

With the advent of Systems-on-Chip for functional safety applications and novel levels of multi-core integration, safety products are getting more compact and more energy efficient. One way of achieving high levels of performance and utilization on such a system is to use hypervisors. A hypervisor partitions the hardware resources (e.g., CPU, RAM, peripherals) into several separate virtual machines that can be used independently.

However, in the safety applications, the hypervisor not only itself should operate in a safe and secure way but should also maintain the isolation between the virtual machines, so that one faulty machine does not jeopardize the operation of others.

The focus of this master thesis is to study and evaluate today's open-source hypervisors and railway standards such as EN 50128 and IEC 61508-3. With reading the standards the candidate(s) shall devise a metric to evaluate and measure the gaps of available hypervisors to the requirements of safety applications in the railway domain. Also, the candidate(s) shall specify techniques and methods that need to be added to the top-rated hypervisor from the evaluation to meet the requirements for the highest level of safety of EN 50128.

The candidate shall have a good knowledge and understanding of the following areas:

1. Computer Architecture.
2. Realtime systems and Operating Systems
3. Software programming

### Type of degree project (can be both)

Master (20 weeks):

Bachelor/Högskoleingenjör (10 weeks):

### Language for the thesis

Swedish:  and/or English:

### Is Swedish a language requirement?

Yes:

No:

No, but Swedish is a requirement for future employment:

**Possibility to work from our office**

Yes:

No:

**Contact person**

Sina Borrami                      Hardware Designer  
sina.borrami@alstomgroup.com

Jonas Melchert                      Software Engineer  
jonas.melchert@alstomgroup.com

# EMI immune probe design exploration and implementation

## ALSTOM

### Background

Leading societies to a low carbon future, Alstom develops and markets mobility solutions that provide the sustainable foundations for the future of transportation. Our product portfolio ranges from high-speed trains, metros, monorail, and trams to integrated systems, customised services, infrastructure, signalling and digital mobility solutions. Joining us means joining a caring, responsible, and innovative company where more than 70,000 people lead the way to greener and smarter mobility, worldwide.

Balise is a wireless transponder used as a beacon in many train signal systems in the world, Among them, the European system: ERTMS. This system has been designed for optimal performance and availability. Balise is exposed to a harsh environment, where there're different types of debris, e.g. metal objects, iron ore, clear water, salt water. These debris together with temperature cycling would have impact on Balise's uplink characteristics.

Therefore, during the design and development, the Balise transmission performance needs to be measured and evaluated. However, the traditional measurement tool suffers from lab EM disturbance.

### Problem description and goals

The focus of this master thesis is the architecture design and implementation of an EMI immune measurement tool, to measure and characterise the transmission flux of a Balise or Antenna, then transfer the signal via optical fibre to PC for signal processing.

Within the required responsibilities the candidate should:

- Based on system level specifications, establish block level specifications, identify key-problem and propose/analyse different architectures that would meet specifications.
- Based on block level specifications, select and justify the components which will together build up the measurement tool.
- Compare and analyse the measurement result with DSP between the traditional measurement probe and the EM immune measurement probe.

### Qualification:



For this thesis work we would like to have students who are in the study of M.Sc. in Electronics, Photonics, or Physics with good theoretical knowledge and proven practical experience in the following areas:

Lab activities  
Electronics design  
Signal processing  
Fluent in English  
Self-motivated

**Type of degree project (can be both)**

Master (20 weeks):

Bachelor/Högskoleingenjör (10 weeks):

**Language for the thesis**

Swedish:  and/or English:

**Is Swedish a language requirement?**

Yes:

No:

No, but Swedish is a requirement for future employment:

**Possibility to work from our office**

Yes:

No:

**Contact person**

Anders Rehn                      Hardware Designer  
anders.rehn@alstomgroup.com

Thomas Eriksson                Product Designer  
thomas.eriksson@alstomgroup.com

# Metallic objects CAD design for Big Metal Masses Research

## ALSTOM

### Background

Leading societies to a low carbon future, Alstom develops and markets mobility solutions that provide the sustainable foundations for the future of transportation. Our product portfolio ranges from high-speed trains, metros, monorail, and trams to integrated systems, customised services, infrastructure, signalling and digital mobility solutions. Joining us means joining a caring, responsible, and innovative company where more than 70,000 people lead the way to greener and smarter mobility, worldwide.

Both Balises and onboard system suffers from metallic objects on track. Some of them would have slight impact on the transmission performance, while some of them would trigger alarms for onboard system.

Measurements with big metal masses have been performed in lab with a reference loop which is a lab equipment. It would be interesting and beneficial to do a research, to see the feasibility of characterising with the antenna which is already mounted on the train. In this way, the antenna can be used on a test train or maintenance vehicle for preventive purposes.

### Problem description and goals

The feasibility study has two parts, the first step is to investigate different metallic object that would appear on track and that would have impact on the onboard system(e.g. cause sporadic antenna test failure). The second step is the feasibility study of BMM characterisation with the existing antenna on the train.

The scope of this thesis will focus on the first part above. Within the required responsibilities the candidate should:

- Perform a technological survey of the metallic objects that might be placed on track and might appear on track.
- Perform a research for metallic objects which wouldn't appear on real track, but would provide informative data for the feasibility study of the characterization with train antenna.
- Based on the study above, do design calculations and CAD design of the metallic objects(DfM)

### Qualification:

For this thesis work we would like to have students who are in the study of M.Sc. in Mechanical Engineering with good theoretical knowledge and proven practical experience in the following areas:

Mechanical CAD design  
Design for manufacturing  
Fluent in English  
Self-motivated

**Type of degree project (can be both)**

Master (20 weeks):

Bachelor/Högskoleingenjör (10 weeks):

**Language for the thesis**

Swedish:  and/or English:

**Is Swedish a language requirement?**

Yes:

No:

No, but Swedish is a requirement for future employment:

**Possibility to work from our office**

Yes:

No:

**Contact person**

Anders Rehn  
anders.rehn@alstomgroup.com

Hardware Designer

Thomas Eriksson  
thomas.eriksson@alstomgroup.com

Product Designer

## Master's Thesis:

### Fault slip through analysis

#### Background

Because we are developing high availability safety critical applications it is important to have good feedback mechanisms to know which type of defects that slip through our current testing efforts. Today we do not measure this on a regular basis. Therefore, it would be a good initiative to identify which and how many of our known defects that slip through our current test activities of component testing, sub-system testing, system testing and to the customer.

#### Objective

To analyze and measure which defects that slip through our current test activities and to the customer.

The project will consist of the following tasks:

1. Do a defect analysis of found defects in component testing. Also identify which defects that are found later that should have been able to find in component testing.
2. Do a defect analysis in the same way on sub-system level, i.e. to identify found categories of defects and which defects that slip through to a later phase or to the customer.
3. Do a defect analysis on system level to identify which types of defects are found and which defects slips through to the customer.
4. Make a conclusion of all defects found by the customer to identify where they should have been found earlier.

#### Application

Prerequisites: Good analytical ability and complex system knowledge. Knowledge in software test techniques and root cause analysis is also valuable.

For more information, contact

Anders Claesson  
Anders.claesson@rail.bombardier.com  
073-433 1815

# Thesis project – Safe Runtime Configuration Data Entry

## Background

The INTERFLO150 solution is a computer based train control system used in industrial applications. The system interfaces a number of external systems in the process of loading and unloading material. As part of this the configuration of the train requires detailed information about the vehicles within the train including, but not limited to, vehicle length, vehicle identities, brake properties, material capacity etc. Some of these properties are critical to maintaining the safety of the system. Each vehicle in the system is configured with the type of vehicle, identity etc.

Today there is no process in which the customer can directly add or remove vehicles or change properties of the vehicle types.

## Scope of the work

The scope of the thesis work is to create a proof of concept a vehicle database where:

- a user can add, remove or change templates for vehicle types,
- a user can add, remove or change entries,
- a user can sign one or more entries,
- a second user (verifier) can sign that the entries have been verified,
- entries can be imported and signed from an existing source,
- the application can load/request entries on demand,
- the application can verify the signature on an entry without having to verify the complete dataset,
- strict guarantees to the application that no entries have been lost or changed after verification,
- the application can implement the verification in safety critical software (no external libraries etc.),
- entries are backup to an on-site or off-site location.

## Key responsibilities

- Create a backend for storing entries
- Investigate techniques for signing entries based on Scope of Work, for example Merkle Tree,
- Create a simple user interface that can add, remove, edit, verify and show entries
- Create a proof of concept program that can retrieve entries using a key and verify individual entries. This shall not rely on external libraries or not allowed operations, such as floating point operations or unrestricted memory allocation.
- Prove that alteration of the data will be detected during verification in the application.
- Create an API or proof of concept script for importing data from an external source where the data is signed after the import is done.
- Investigate how keys used to sign entries could be securely distributed.
- Setup a backup process for the vehicle database.

## Location

The thesis work shall be made in Alstom D&IS division located in Göteborg. The students shall be located in the office in Polhemsplatsen 5 during the major part of the work.

## Contact person

**Anders Palmér**

Alstom

Email: [anders.palmer@alstomgroup.com](mailto:anders.palmer@alstomgroup.com)

Mobile: +46 (0)76 877 25 67

# Utvärdering av belysningsystem

## Jernhusen

### Background

Smarta belysningsstyrningar som integrerar med andra fastighetstekniska system kommer vara en självklarhet i framtiden. Vi på Jernhusen tar gärna hjälp av någon som kan sätta sig in i olika lösningar och gå på djupet gällande funktionalitet, kvalitet, säkerhet, möjlighet till integration etc.

### Problem description, tasks, and goals

Problemet idag är att olika typer av standarder inte tydligt framgår i leverantörernas helhetslösningar. Vi vill hitta systemlösningar för framtiden och inte en leverantör/product. Målsättningen är att ta fram en "manual" som beskriver olika lösningar med dess styrkor och svagheter.

### Type of degree project (can be both)

Master (20 weeks):

Bachelor/Högskoleingenjör (10 weeks):

### Language for the thesis

Swedish:  and/or English:

### Is Swedish a language requirement?

Yes:

No:

No, but Swedish is a requirement for future employment:

### Possibility to work from our office

Yes:

No:

### Contact person

Daniel Larsson

Daniel.larsson@jernhusen.se

Automationsingenjör





# Assignments in rail traffic

## SL Region Stockholm

### Background

The assignments for rail traffic are in the following areas: Traffic, Operation and maintenance, Organization and processes, Technology in traffic control and signalling

### Problem description, tasks, and goals

The purpose of all different master thesis that deal with orientation and choice of technology for systems and working methods for rail traffic is to contribute to and ensure that both asset management and development perspectives are taken into account currently in this moment and in the future.

### Type of degree project (can be both)

Master (20 weeks):

Bachelor/Högskoleingenjör (10 weeks):

### Language for the thesis

Swedish:  and/or English:

### Is Swedish a language requirement?

Yes:

No:

No, but Swedish is a requirement for future employment:

### Possibility to work from our office

Yes:

No:

### Contact person

HR  
student@sl.se                      Team Student about practical things: application, assignment

Andreas  
andreas.martensson@regionstockholm.se                      To discuss interest in: different areas, ideas, work performance

Kristina  
kristina.lovenberg@regionstockholm.se                      To discuss interest in: different areas, ideas, work performance



## **Enable digital transformation with RMD innovations in rail.**

### **RMD – Railway Metrics and Dynamics AB / Omicron Ceti AB**

#### **Background**

Railway Metrics and Dynamics (RMD) develops sensor systems and sells services based on sensor data analysis. Supported by Omicron Ceti AB. Sensors and services are already delivered to rail vehicle owners and operators in Sweden and world-wide. RMD is also commissioned by Swedish infrastructure owner Trafikverket through an innovation tender. The aim is to complement today's infrequent infrastructure inspections by instrumenting trains in traffic with RMD's Performance Measuring Units and using machine learning to improve decision support for infrastructure maintenance. Initial focus on a. Tracks, b. Overhead power-line (OHL)

#### **Problem description, tasks, and goals**

Problem: How can we enable digital transformation with RMD innovations? Tasks: follow in the steps of our present and new partners: A. Rohan Kulkarni - rkulkarni@kth.se - "Onboard condition monitoring of vehicle-track dynamic interaction using machine learning: Enabling the railway industry's digital transformation". B. William Liu - zhendong@kth.se - "Measures to Enhance the Dynamic Performance of Railway Catenaries,". C. Bastian Schick - bschick@kth.se - "Pantograph-catenary dynamic interaction". Goals: Enable digital transformation with RMD innovations.

#### **Type of degree project (can be both)**

Master (20 weeks):

Bachelor/Högskoleingenjör (10 weeks):

#### **Language for the thesis**

Swedish:  and/or English:

#### **Is Swedish a language requirement?**

Yes:

No:

No, but Swedish is a requirement for future employment:

#### **Possibility to work from our office**

Yes:

No:

#### **Contact person**

Peter Melander / Kenneth Wriife

Role

peter.melander@railwaymetrics.com / ken@omicron.se



# Automatic Classification of Vehicle Damage Records

**SJ AB**

## **Background**

SJ operates a large fleet of trains. Maintenance of this fleet falls under two maintenance categories: preventive maintenance (förebyggande underhåll, FU) and corrective maintenance (avhjälpande underhåll, AU). FU is carried out either based on kilometers or hours and is described in our maintenance plan, specific to each vehicle type. Corrective maintenance is performed as needed.

The need for AU arises when someone, often a workshop, onboard personnel, driver, or depot, detects damage to the vehicle and reports it through one of our reporting channels. These damages, unless safety-critical, which have their own procedure, are then forwarded to the workshop for repairs.

It is through reviewing and recording these AU reports that vehicle engineers in the vehicle division discover new types of damage, track trends, and monitor which subsystems are beginning to wear out or require anything from specific interventions to entirely new FU approaches.

AU reports provide the opportunity to enter all necessary information about the damage, such as the vehicle "carriage," the timing, the component involved, and the action taken to address the damage.

## **Problem description, tasks, and goals.**

Since AU reports are created by individuals with varying technical knowledge, interest, and time constraints, there is much room for improvement in the quality of these entries. Often, they are misclassified, misspelled, and formatted in a generally messy manner. This makes it difficult to categorize and track the trends we genuinely want and should be able to follow. There is a lot of noise in the data, resulting in the need for significant technical expertise in the system for follow-up and trend analysis. This makes the data ambiguous and often hard to access.

### **Type of degree project (can be both)**

Master (20 weeks):

Bachelor/Högskoleingenjör (10 weeks):

### **Language for the thesis**

Swedish:  and/or English:

### **Is Swedish a language requirement?**

Yes:

No:

No, but Swedish is a requirement for future employment:

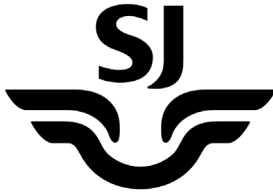

# Develop a door computer for train coaches

## SJ AB

### Background

As vehicles are getting older the technology used is slowly outdated and spare parts are not any longer possible to buy or produce. An example of this is the PLC computer containing all the intelligence and functionality for steering of the doors in the passenger coaches. SJ needs a new computer to be able to keep the coaches in traffic in the future.

### Problem description, tasks, and goals

Pre-study: Analyse the current computer technology and the functionalities that it provides.

Technical solution: Find an existing PLC computer that is railway compatible according to all regulations with safety integrity level 3 or above. Write code for the new PLC computer that fulfils today's railway requirements and adds the possibility to communicate with new train monitoring system for passenger coaches. The aim of monitoring the signals is to increase reliability, availability, and maintainability of the door systems. The doors are crucial for passenger safety and therefore much effort must be put on safety matters. A new computer with code must be able to replace the old computer to full extent. Final report: A written technical report and a presentation of the findings to involved roles and functions at SJ. The report should describe the technical solution and a recommendation on how to implement it.

### Type of degree project (can be both)

Master (20 weeks):

Bachelor/Högskoleingenjör (10 weeks):

### Language for the thesis

Swedish:  and/or English:

### Is Swedish a language requirement?

Yes:

No:

No, but Swedish is a requirement for future employment:

### Possibility to work from our office

Yes:

No:

### Contact person

Leonardo Ahumada  
hogskolegruppen@sj.se

Vehicle Engineer

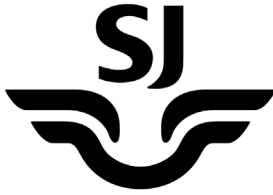

# Enhancing Efficiency in Vehicle Damage and Spare Parts Management at SJ

**SJ AB**

## **Background**

SJ possesses an extensive and multifaceted fleet of trains spanning various ages and conditions, forming a large and diverse collection. This diversity in the train inventory gives rise to an even more multifaceted and intricate challenge when it comes to managing spare parts and damages. The variation, in turn, places high demands on workshop inventory management and the precision of vehicle documentation. With such a comprehensive and vast array of train models covering a wide span of time, a sophisticated and well-informed strategy is required to maintain efficient operations by ensuring that the right spare parts are available at the right time and that crucial information about each vehicle is meticulously documented and easily accessible.

## **Problem description, tasks, and goals**

Currently, identifying which component one is looking at, where it is located, and whether it is available on the spare parts shelf involves consulting manuals and sifting through lengthy and outdated tables with numbers and names. The goal is to develop improved methodologies and/or tools that enable rapid and accurate identification of damaged components, their part numbers, and their exact location on board the train. This can be achieved by either enhancing the reporting process or optimizing inventory management. By doing so, the aim is to enhance efficiency and precision in spare parts and damage management, ultimately leading to smoother and more reliable train fleet operations.

## **Type of degree project (can be both)**

Master (20 weeks):

Bachelor/Högskoleingenjör (10 weeks):

## **Language for the thesis**

Swedish:  and/or English:

## **Is Swedish a language requirement?**

Yes:

No:

No, but Swedish is a requirement for future employment:

## **Possibility to work from our office**

Yes:

No:

## **Contact person**

Joel Elinder

Vehicle Engineer X2000

hogskolegruppen@sj.se

**Possibility to work from our office**

Yes:

No:

**Contact person**

Joel Elinder

Vehicle Engineer X2000

hogskolegruppen@sj.se

# Automation in timetable construction

## Sweco Sverige AB – Tågtrafik & Logistik (Railway traffic & Logistics)

### Background

The railway is a complex system, and we are facing a paradigm shift in the industry where automation and artificial intelligence are creating new opportunities. Today, timetables are manually constructed and evaluated in a lengthy process. The train schedule, which takes months to produce, then determines the traffic for one year at a time. If the process is streamlined, timetable and train traffic planning can become more flexible, enabling more capacity to handle disruptions and changes that may arise.

### Problem description and goals

The thesis proposal is about using data on infrastructure and vehicle performance to create a timetable that maximises resources. This can be achieved by using algorithms and artificial intelligence to automate parts or all of the timetable construction process. A case study of a railway line can be used to investigate this, and the output can be a generated timetable for further analysis on how it can be optimally used to transport more passengers or goods.

### Type of degree project (can be both)

Master (20 weeks):

Bachelor/Högskoleingenjör (10 weeks):

### Language for the thesis

Swedish:  and/or English:

### Is Swedish a language requirement?

Yes:

No:

No, but Swedish is a requirement for future employment:

### Possibility to work from our office

Yes:

No:

### Contact person

Stefan Bojander  
stefan.bojander@sweco.se

Group manager Railway traffic & Logistics

# Ballast cleaning for the Swedish railways

## SWECO – Transport, Railway

### Background

SWECO is the leading architecture and technical consultant company in Europe with 20 000 employees throughout the continent. Within the railway sector, we have experts in all technical disciplines, e.g. track technology and design, signalling systems and traffic control, electric power system, rolling stock and railway capacity. This degree project proposal is set in the context of the maintenance of the railway track system, with a focus on the ballast cleaning process. Ballast cleaning is the most used maintenance approach to improve the capabilities of the ballast layer. For this project, you need to have a background in railway track technology and/or geotechnical engineering.

### Problem description and goals

The ballast layer is an essential part of the ballasted railway track. It is the upper layer in the railway foundation which should withstand the vertical, lateral and longitudinal forces that occurs with train movements. At the same time, it should also be able to let through the surface water. However, after numerous amounts of cyclic loading from the railway traffic, the ballast layer is degraded by wear and breakage of the particles, as well as from the environment around it, which reduces the desired effects. The typical maintenance approach for improving the ballast quality is to clean the ballast, where the fouled particles are sieved and deposited. Beforehand, site visits are made, and particle degradation curves are often extracted at even distances, to have an idea of the in-situ quality and, furthermore, the need of supplementary ballast, the need of storage areas, and estimated production pace. However, these are only estimations made with the known data, and the real outcome often differ greatly. One part of this project is to do an analysis of the latest research of the topic and what is made in other countries regarding keeping track of the ballast quality. Another part is to dig deep into the factors involved in the process of mass handling for ballast cleaning. Possible outcomes are recommendations on how to improve the mass handling process of ballast cleaning, with a focus of mass estimation, and recommendations of methods to keep track of the ballast quality at the Swedish railways.

### Type of degree project (can be both)

Master (20 weeks):

Bachelor/Högskoleingenjör (10 weeks):

### Language for the thesis

Swedish:  and/or English:

### Is Swedish a language requirement?

Yes:

No:

No, but Swedish is a requirement for future employment:

### Possibility to work from our office

Yes:

No:

Depending on the outline of the thesis, it can be needed to work partly at KTH.

### Contact person

Karl Norberg

Railway engineer/Investigator

karl.norberg@sweco.se



## Improvement of Railway Vehicle Maintenance Planning with the Use of AI

### SWECO – Rolling Stock, Railway

#### Background

SWECO is the leading architecture and technical consultant company in Europe with 20 000 employees throughout the continent. Within the railway sector, we have experts in all technical disciplines, e.g., track technology and design, signalling systems and traffic control, electric power system, rolling stock and railway capacity.

#### Problem description and goals

Develop a conceptual approach to applying artificial intelligence (AI) to analyze data from condition-based maintenance of railway vehicles, with the aim of optimizing and improving maintenance planning for rail operators.

Parts:

1. Literature review: \*\* - Review of existing literature and research related to condition-based maintenance, rail vehicles, and the use of AI in maintenance planning.
2. Interviews
  1. With rail operators regarding their current use of data collection and analysis for condition based maintenance
  2. With representatives from other industries where AI is already being utilized for maintenance purposes.
3. Data sources and Data availability: \*\* - Identify potential data sources and data collection systems that can be used to collect relevant data on the condition and maintenance history of railway vehicles.
4. AI Models and Techniques: \*\* - Explore different AI models and techniques that can be applied to the collected data to detect patterns, predict failures, and optimize maintenance planning.
5. Model evaluation: \*\* - Evaluate the potential AI models through simulations and prototypes to assess their effectiveness and accuracy in predicting maintenance needs.
6. Conceptual Strategy Development: \*\* - Develop a conceptual strategy describing how AI technology can be integrated into railway operators' existing maintenance processes. The strategy should include methods to monitor, update, and adapt AI models over time.
7. Implementation guidance: \*\* - Create an implementation guidance that describes step-by-step how rail operators can start using the proposed strategy and integrate AI into their maintenance planning.

Objectives for the degree project:\*\*- Identify how AI technology can be used to improve the efficiency and reliability of maintenance planning for railway vehicles.- Develop a conceptual strategy that can be used as a basis for integrating AI into practice for railway operators.- Evaluate the potential benefits and challenges of implementing AI in railway vehicle maintenance.- Contribute to the knowledge base in the field of condition-based maintenance and AI applications in railway industry.

This thesis will explore the possibilities that AI technology offers to transform and streamline maintenance planning for railway vehicles, and it does not require advanced programming knowledge, but rather an ability to conceptually understand and plan the use of AI technology.

**Type of degree project (can be both)**

Master (20 weeks):

Bachelor/Högskoleingenjör (10 weeks):

**Language for the thesis**

Swedish:  and/or English:

**Is Swedish a language requirement?**

Yes:

No:

No, but Swedish is a requirement for future employment:

**Possibility to work from our office**

Yes:

No:

Depending on the outline of the thesis, it can be needed to work partly at KTH.

**Contact person**

Niklas Johansson                      Senior Maintenance Expert  
niklas.johansson2@sweco.se

# Intermodal reloading hubs

## SWECO – Transport, Railway

### Background

SWECO is the leading architecture and technical consultant company in Europe with 18 500 employees throughout the continent. Within the railway sector, we have experts in all technical disciplines, e.g. track technology and design, signalling systems and traffic control, electric power system, rolling stock and railway capacity. This degree project proposal is set in the context of the railway capacity and logistics for freight operations. The intermodal freight transport has continuously increased during recent decades. To make the transitions between transport modes, intermodal terminals are used. However, these require a lot of space and are quite time consuming in the reloading sequence.

### Problem description and goals

This degree project seeks to dig deep into the future of intermodal reloading hubs. There are high demands on the effectiveness of logistical capacity and flow of both goods and vehicles. The study should include a solid literature study and discussion regarding the intermodal freight of today and the future, with the focus on the reloading hubs. How is the reloading of goods functioning today and how can it be improved? Depending on outline of the study, simulations with Railsys can be included.

### Type of degree project (can be both)

Master (20 weeks):

Bachelor/Högskoleingenjör (10 weeks):

### Language for the thesis

Swedish:  and/or English:

### Is Swedish a language requirement?

Yes:

No:

No, but Swedish is a requirement for future employment:

### Possibility to work from our office

Yes:

No:

### Contact person

Stefan Bojander  
stefan.bojander@sweco.se

Group manager Railway traffic & Logistics

# Motorail traffic in Sweden

## Sweco Sverige AB – Tågtrafik & Logistik (Railway traffic & Logistics)

### Background

Motorail, where passengers travel in regular passenger coaches while their vehicles are transported on car-transport wagons, could be a solution to manage seasonal peaks in holiday car travel, reduce the environmental impact of holiday trips, and decrease accident risks on the road network. This can be achieved by replacing long-distance car journeys with train journeys, with the car only used for transportation to and from the motorail terminals. Motorail combine the energy efficiency and low emissions per passenger-kilometer of trains with the range, convenience, and flexibility of cars during vacations. Additionally, the long-distance travel can be conducted overnight as a night train.

### Problem description and goals

A prior thesis researched the possibility to implement motorail traffic in Sweden and there is a lot of research areas to continue researching. A further study could include examining the attitudes of travelers towards and their willingness to travel by motorail, investigating customer demographics and their travel habits, studying operators and infrastructure owners' perspectives on motorail, and investigating financing models for motorail traffic and associated infrastructure. Further studies could also investigate the socio-economic effects of motorail traffic, comparisons with other traffic to determine which should be prioritized in the train planning process, optimal geographic location and design of motorail stations.

### Type of degree project (can be both)

Master (20 weeks):

Bachelor/Högskoleingenjör (10 weeks):

### Language for the thesis

Swedish:  and/or English:

### Is Swedish a language requirement?

Yes:

No:

No, but Swedish is a requirement for future employment:

### Possibility to work from our office

Yes:

No:

### Contact person

Stefan Bojander  
stefan.bojander@sweco.se

Group manager Railway traffic & Logistics

# More efficient maintenance planning

## SWECO – Transport, Railway

### Background

Great volumes of freight is transported every day at the Iron ore line in north of Sweden with large financial values. Every year planned maintenance windows on the line affects the possibility to transport freight and as a result have impact on the industries finances.

### Problem description and goals

This thesis proposal focuses on the possibility to find alternative maintenance solutions from a traffic point of view. This may come at a greater maintenance cost but on the contrary generate more value for the industries transporting goods. The methods used could involve timetable construction in RailSys, socioeconomic evaluation and financial analysis.

### Type of degree project (can be both)

Master (20 weeks):

Bachelor/Högskoleingenjör (10 weeks):

### Language for the thesis

Swedish:  and/or English:

### Is Swedish a language requirement?

Yes:

No:

No, but Swedish is a requirement for future employment:

### Possibility to work from our office

Yes:

No:

### Contact person

Stefan Bojander  
stefan.bojander@sweco.se

Group manager, Railway traffic & Logistics

# Effects of prioritising freight operation in timetable construction

## SWECO – Transport, Railway

### Background

Today, the capacity allocation is a complicated process conducted every year to enable a secure and functioning traffic on the rail network. The process involves evaluation of demand and supply in relation to socioeconomic benefits. Due to the different characteristics between freight and passenger traffic in combination with limited available capacity, there will be conflicts and a need to prioritise.

### Problem description and goals

Freight traffic is usually disfavoured and referred to night time operation and long transfer times due to overtakes by faster passenger trains. This thesis proposal focuses on alternatives to the usual capacity allocation. Taking aim in firstly planning for freight traffic and secondly passenger traffic and evaluating its effects. This could be done in the form of case study consisting of a timetable construction in RailSys on a main line or an important goods corridor. Followed by an evaluation of socioeconomic and environmental benefits.

### Type of degree project (can be both)

Master (20 weeks):

Bachelor/Högskoleingenjör (10 weeks):

### Language for the thesis

Swedish:  and/or English:

### Is Swedish a language requirement?

Yes:

No:

No, but Swedish is a requirement for future employment:

### Possibility to work from our office

Yes:

No:

### Contact person

Stefan Bojander  
stefan.bojander@sweco.se

Group manager, Railway traffic & Logistics

# Strategy for a clock-face timetable for Norrtåg's future service on the line Sundsvall-Luleå

## Sweco Sverige AB – Tågtrafik & Logistik (Railway traffic & Logistics)

### Background

The operator Norrtåg is designing a strategy for its whole railway system. The large future plan is based on the new line Norrbottenbanan to Luleå which enables travelling along the whole coast line Sundsvall-Umeå-Luleå. Strategically, the focus is that the line should run with a clock-face timetable, where the trains meet at the stations and run at consistent intervals. This enables smooth travelling with connecting public transport in all relationships. It has already been established that a desirable timetable requires new regional trains for 250 km/h.

### Problem description and goals

It is likely that the design of today's Ådalsbana and Botniabana, as well as the planned Norrbottenbanan, do not provide sufficient capacity and accessibility for an optimal clock-face timetable to be introduced. By analyzing the traffic in Railsys, the aim of this thesis is to identify what deficiencies exist in the infrastructure and preferably also propose what additional infrastructure measures are required to achieve a clock-face timetable for the Norrtåg line with trains at 250 km/h.

### Type of degree project (can be both)

Master (20 weeks):

Bachelor/Högskoleingenjör (10 weeks):

### Language for the thesis

Swedish:  and/or English:

### Is Swedish a language requirement?

Yes:

No:

No, but Swedish is a requirement for future employment:

### Possibility to work from our office

Yes:

No:

### Contact person

Stefan Bojander

Stefan.bojander@sweco.se

Group manager Railway traffic & Logistics

# Vertical track stiffness in the design process

## SWECO – Transport, Railway

### Background

SWECO is the leading architecture and technical consultant company in Europe with 20 000 employees throughout the continent. Within the railway sector, we have experts in all technical disciplines, e.g. track technology and design, signalling systems and traffic control, electric power system, rolling stock and railway capacity. This degree project proposal is set in the context of the railway track system, including both track technology and geotechnical engineering. The vertical track stiffness is a measurement of the elasticity of the track, therefore including all components of the track from rail to subsoil. For this project, it is beneficial if you have a background in either railway track technology and/or geotechnical engineering, as well as having experience with FEM.

### Problem description and goals

In theory, vertical track stiffness is a simple measurement of the elasticity of the track. There are multiple ways to measure it on site at existing tracks. However, it is more difficult to make assumptions for the resulting track stiffness in the design process of a new or renewed track section. This degree project seeks to come closer to an answer on how to apply the governing rules of vertical track stiffness in the design stage. One goal with this project is to get an understanding of the vertical track stiffness and different models of calculating it. A further goal is to evaluate the influence, and how approximate the behaviour, of different components/layers in the track structure and to evaluate different approaches to calculate the track stiffness. In the end, the result should be connected to how the demands of track stiffness could, or should, be handled in the design process.

### Type of degree project (can be both)

Master (20 weeks):

Bachelor/Högskoleingenjör (10 weeks):

### Language for the thesis

Swedish:  and/or English:

### Is Swedish a language requirement?

Yes:

No:

No, but Swedish is a requirement for future employment:

### Possibility to work from our office

Yes:

No:

Depending on the outline of the thesis, it can be needed to work partly at KTH.

### Contact person

Karl Norberg

Railway engineer/Investigator

karl.norberg@sweco.se



## Optimization of rail vehicle design within asset management framework

### Background

One of the problems in the management of an asset, like a rail vehicle and rolling stock in general, is the lack of alignment and coordination between different entities that contribute during different stages of the asset life cycle. In particular, during the design phase strong emphasis is put in delivering a product according to economic and design requirements without considering other important factors that may influence the future costs and overall success of the asset. At Systra we offer consulting services in the asset management to different stakeholders of the Swedish railway industry such as SJ, Trafikverket, SL, Alstom with focus on realising the best value from their assets.

### Problem description, tasks, and goals

During inspection process of rail vehicles after manufacturing, the design of components and subsystems is controlled in order to grant quality levels in the production according to the requirement of the customer. Among the faults founds some could be avoided in the design phase if the focus is put not only in delivering a product that satisfy the design requirements but also the needs faced along the whole life of the asset (e.g. easy accessibility of key components for maintenance, replacement of parts that may become obsolete etc.). In this context, using available data from an inspection software, you will help us in identifying the possible improvements in the design of the train than can save costs in the future life of the rail vehicle.

Your activities include (but are not limited to):

- Literature review on Asset Management and related digital solutions with focus on the different stages of asset life cycle.
- Define a breakdown structure of the rolling stock asset and understand the functioning of the current inspection software and possible improvements.
- Analyse data from the inspection software (but also other digital AM tools can be included) and identify components and/or subsystems that can be improved.
- Propose a solution for improvements in the rail vehicle with clear motivation (e.g. economic analysis, CAD model, risk assessment etc.)

The skills we look for:

- Railway system: You have a sound knowledge of the railway system (esp. rolling stock) and the various subsystems that comprise it.
- First principles of systems engineering, mechanical & electrical engineering
- Documentation: You can do a thorough literature survey with attention to detail and present your findings in an organized manner. You are comfortable with Swedish documents. You are good in Microsoft Office.
- Willingness to learn: You will go through a steep learning curve and need to be prepared to grasp diverse skillsets such inspection software, maintenance data etc.

- Independent & collaborative: You will need to take the initiative to engage with various people during the assignment.

**Type of degree project (can be both)**

Master (20 weeks):

Bachelor/Högskoleingenjör (10 weeks):

**Language for the thesis**

Swedish:  and/or English:

**Is Swedish a language requirement?**

Yes:

No:

No, but Swedish is a requirement for future employment:

**Possibility to work from our office**

Yes:

No:

**Contact person**

Daniele Fraschini  
dfraschini@systra.com

Asset Management Consultant

## Digital twin architecture of rolling stock with a focus on asset management

### Systra

#### Background

One of the main problems faced by the Swedish railway industry is breakdown of rolling stock operations due to various reasons such as obsolete components, changing regulations and legacy methods for asset register, and maintenance crunch amongst others. In Systra we consult for various stakeholders in the Swedish railway industry such as SJ, SL and Alstom, on asset management of rolling stock with an increasing push towards digitalization. Our experience places us at a unique position to cater to the future needs of the rolling stock operators to realise the maximum value from their assets.

#### Problem description, tasks, and goals

At Systra we are exploring digital solutions to help us with predictive maintenance of rolling stock and reduce time in identifying and resolving faults in the asset. In this we envision a connected digital eco-system encompassing rolling stock-focussed activities such as inspection at different stages of asset lifecycle, operation, safety assessment, inventory management, vehicle certification etc. A first step in this initiative is building a digital twin architecture of the asset. In this you will help us with the development of the methodology to do so.

Your activities include (but not limited to)

- Perform a literature survey of digital twin applications in the railway sector with a clear focus on asset performance and maintenance
- Define the ontology of a rolling stock asset with clearly-specified causal relationships on the Microsoft Azure platform (See [example](#)) . You are also welcome to propose alternative platforms
- Identify various subsystems that make up the asset and work with vehicle documentation to create its digital representation
- For a chosen subsystem, assign/define asset performance indices in the lines of Form, Function, Safety, and System that help is making choices for the asset owner

The skills we look for:

- Railway system: You have a sound knowledge of the railway system (esp. rolling stock) and the various subsystems that comprise it
- First principles of systems engineering, mechanical & electrical engg.
- Documentation: You can do a thorough literature survey with attention to detail and present your findings in an organized manner. You are comfortable with Swedish documents. You are good in Microsoft Office
- Willingness to learn: You will go through a steep learning curve and need to be prepared to grasp diverse skillsets such as Azure platform, inventory management, etc

- Independent & collaborative: You will need to take the initiative to engage with various people during the assignment

**Type of degree project (can be both)**

Master (20 weeks):

Bachelor/Högskoleingenjör (10 weeks):

**Language for the thesis**

Swedish:  and/or English:

**Is Swedish a language requirement?**

Yes:

No:

No, but Swedish is a requirement for future employment:

**Possibility to work from our office**

Yes:

No:

**Contact person**

Visakh V Krishna, PhD  
vkrishna@systra.com

Asset management consultant

# Examensarbete - signalsystemets samverkan med tågskyddssystemet

Utredning av användning av 100 kPa-läget i tågskyddssystemet.

## Uppdragsgivare

Trafikverket – signal styrning, nationell organisation.

## Beskrivning av ämnet

I ombordsystemet ATC finns möjligheten att ställa in en reducerad bromsverkan vid systembromsning till 2/3 retardation. Inställningen ger information till tåget att börja bromsa tidigare och kan användas vid misstanke om låga adhesionsförhållanden. Tågskyddssystemet behöver därför få information från signalsystemet via baliser på ett tillräckligt avstånd relaterat till hastighet och banans lutning. Ett tillräckligt avstånd motsvarar avstånden i normaltabellen TRVINFRA 00302 kap 13. Signalsystemets utformning och dimensionering garanterar inte normaltabellens avstånd idag. Ett arbete med att kunna köra längre godståg i högre hastigheter (LTS-projektet) har även använt marginaler i systemet som tidigare var avsatta för 100 kPa-läget upp till och med hastigheter på 120 km/h.

Benämningen 100 kPa-läget benämns även som "mjuk övervakning". Bakgrunden till benämningen är att en fullbromsning motsvarar en trycksänkning av huvudluftledningen med 150 kPa. En reducerad bromsverkan ges om en lägre trycksänkning ges.

## Omfattning

Förslag till examensarbetets frågeställning kan vara

- Kan vi tillåta att köra med inställningen 100 kPa med dagens förutsättningar?
- Vad finns det för risker med att använda 100 kPa läget nu och i framtiden?
- Kan vi ta bort möjligheten att köra med 100 kPa läget och dimensionera signalsystemet utifrån detta?

I examensarbetet ges bland annat möjligheter att

- Kunna delta i ett signalregelverksöversynsprojekt inom interaktion fordon och signalsystem
- Fördjupa sig i tågskyddssystemets funktioner
- Fördjupa sig i tågs bromssystem
- Förstå hur signalsystemet behöver dimensioneras utifrån tågs bromsförmåga
- Göra beräkningar och simuleringar
- Göra bedömningar om trafiksäkerhet utifrån MTO perspektiv, människa teknik organisation
- Påverka framtidens signalregelverk

**Kontaktinformation**

[elisabeth.skoglund@trafikverket.se](mailto:elisabeth.skoglund@trafikverket.se)

[orjan.jonsson@trafikverket.se](mailto:orjan.jonsson@trafikverket.se)

**Frågor**

För frågor nås kontaktpersonerna på mail.

**Ansökan**

Skriv en kort ansökan med en beskrivning av dig själv, din bakgrund och meriter samt varför detta ämne låter intressant.

# Är du vår nyckel till framgång? Bli vår brygga med järnvägsbranchen för framtidens nyckelhantering

## Trafikverket

### Background

Som infrastrukturförvaltare ämnar Trafikverket att implementera system för en online nyckelhantering. Järnvägen som system behöver alla parter med på tåget för att det ska fungera. Vi behöver din hjälp att överbrygga samarbetet mellan Trafikverket och järnvägsoperatörerna och denna gång med operatörerna i fokus. Syftet med examensarbetet är att sammanställa en rekommendation för operatörerna som verkar i Sverige avseende vägval i implementeringen av online nyckelhantering.

Inom den digitaliserade järnvägen är en säker nyckelhantering ett måste. Genom användandet av kryptering kan mottagaren av informationen verifiera att informationen kommer från rätt avsändare och att den är oförändrad. För att hantera utbytet av nycklar mellan mark- och ombordutrustning och möjliggöra interoperabel järnvägstrafik i Europa finns så kallade Key Management Centre (KMC) som ansvarar för nyckelhanteringen inom och mot andra domäner.

Nyckelhanteringen omfattar generering, lagring, distribution och borttagning av nycklar, se övergripande i Figur 1. Alla mark- och ombordutrustningar måste ingå en sådan domän och vara anslutna till en KMC för sin kryptonyckelhantering.

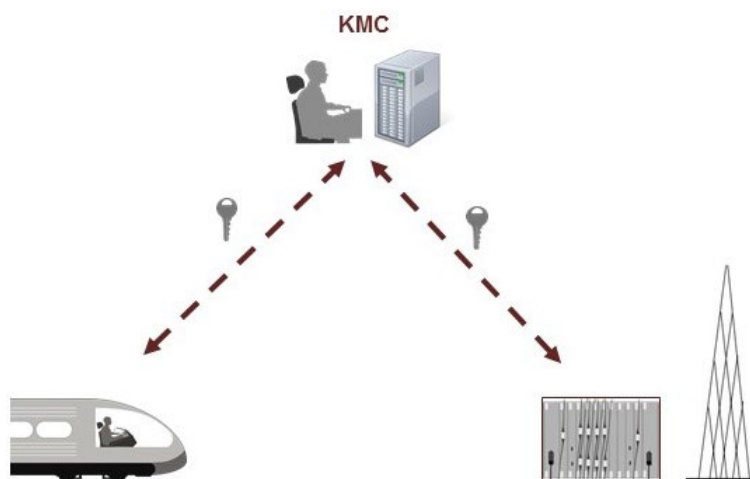

*Figur 1: Kryptonycklar distribueras från KMC till mark- och ombordutrustning. Notera att Trafikverket endast genererar kryptonycklar till sina egna fordon. Till externa fordon genereras kryptonycklarna via extern KMC.*

Idag används offline nyckelhantering men i Sverige är vi på väg att implementera online nyckelhantering inom de kommande åren. Detta är en förutsättning i takt med att järnvägen digitaliseras och vi behöver din hjälp att få med operatörerna på tåget.

**Problem description, tasks, and goals**

Utreda hur frågan om online nyckelhantering har hanterats av andra infrastrukturförvaltare i Europa/omkringliggande länder. Identifiering av krav för KMC ur ett operatörsperspektiv (subsets, gränssnitt, funktioner). Arkitekturellt övergripande lösningsförslag (subsystemets del i helhet). Identifiering av vägval inkluderat för och nackdelar följt av en rekommendation (utveckla själva, upphandla x, upphandla y..). Output: Generell rekommendation för operatörerna som verkar i Sverige sett till vägval avseende implementering KMC-online

**Type of degree project (can be both)**Master (20 weeks): Bachelor/Högskoleingenjör (10 weeks): **Language for the thesis**Swedish:  and/or English: **Is Swedish a language requirement?**Yes: No: No, but Swedish is a requirement for future employment: **Possibility to work from our office**Yes: No: **Contact person**

Anna Jernlund  
anna.jernlund@trafikverket.se

Program manager/Project sponsor



## Trafikverket - Alternativa sätt att elektrifiera järnvägstrafik

<https://kth-exjobb.powerappsportals.com/en-US/View-Uppdrag/?id=60cfc773-3b17-ee11-a81c-6045bd9e41a0>

# Developing Interactive Macroscopic Timetabling Tool

## WSP

### Background

WSP is a multinational company with broad experience of traffic and capacity studies within the railway sector.

### Problem description, tasks, and goals

In the long-term strategic planning process, network assessment and infrastructure capacity planning as well as management could preferably be studied and evaluated with a combination of macroscopic and microscopic approaches. Timetable modelling and simulation tools such as RailSys and OpenTrack are intensively used at WSP. However, these tools are time consuming. To that effect, we would like to develop an interactive macroscopic timetabling tool with programming languages such as Python or Java.

### Type of degree project (can be both)

Master (20 weeks):

Bachelor/Högskoleingenjör (10 weeks):

### Language for the thesis

Swedish:  and/or English:

### Is Swedish a language requirement?

Yes:

No:

No, but Swedish is a requirement for future employment:

### Possibility to work from our office

Yes:

No:

### Contact person

Name Kassaw Bediru Seid

Role Traffic and capacity analyst

Email kassaw.bediru.seid@wsp.com

# How would a new level separated crossing at Katrineholm affect delays?

## WSP

### Background

Trains from many cities for (instance Malmö) towards Stockholm on the Southern Main Line have to cross the southbound track at Katrineholm on the Western Main Line (Gothenburg – Stockholm). WSP is a multinational company with broad experience of traffic and capacity studies within the railway sector.

### Problem description, tasks, and goals

The goal is to have a new level separated crossing on the Western Main Line at Katrineholm so that crossing movements on the Western Main Line are avoided. How would a new level separated crossing on the Western Main Line at Katrineholm so that crossing movements on the Western Main Line are avoided affect the delays in the system?

### Type of degree project (can be both)

Master (20 weeks):

Bachelor/Högskoleingenjör (10 weeks):

### Language for the thesis

Swedish:  and/or English:

### Is Swedish a language requirement?

Yes:

No:

No, but Swedish is a requirement for future employment:

### Possibility to work from our office

Yes:

No:

### Contact person

Emin Kovac  
emin.kovac@wsp.com

Traffic and capacity analyst

# New commuter station at Fågelsta for Östgötapendeln

## WSP

### Background

The commuter line Östgötapendeln runs between Norrköping – Motala / Norrköping – Tranås. As of today, the commuter line Östgötapendeln does not stop at Fågelsta. WSP is a multinational company with broad experience of traffic and capacity studies within the railway sector.

### Problem description, tasks, and goals

The goal is to have a commuter station at Fågelsta for the Commuter line Östgötapendeln. How would a new stop at Fågelsta affect the traffic? Would a new stop require some infrastructure measures?

### Type of degree project (can be both)

Master (20 weeks):

Bachelor/Högskoleingenjör (10 weeks):

### Language for the thesis

Swedish:  and/or English:

### Is Swedish a language requirement?

Yes:

No:

No, but Swedish is a requirement for future employment:

### Possibility to work from our office

Yes:

No:

### Contact person

Emin Kovac

Traffic and capacity analyst

emin.kovac@wsp.com



# Cost Modelling of Optimizing Train Operation and Upgrading Infrastructure for Decision-Making

## Rail Vehicle Unit (in collaboration with SL and MTR)

### Background

The urban rail transport systems in Stockholm are one of the most important parts of public transport for both residents and travelers. They provide a cheap and time-efficient means of transport and help to ease congestion and pollution in urban areas. Even though rail transport is very energy-efficient and runs on green electricity, the power supply systems of the local rail transport are relatively old and weak, which lowers energy efficiency and limits the increase in transport capacity. The power supply systems have become bottlenecks for the development of Stockholm's local rail transport. There are many measures which can help to overcome the bottlenecks, e.g., optimizing train operation and upgrading infrastructure. In order to help the decision-maker make cost-efficient decisions on the development of the local rail transport, a research project on finding solutions for a more sustainable transport system (financed by Vinnova InfraSweden2030) is conducted to set up a smart and cost-effective management plan for efficiently using infrastructure as well as saving energy.

### Description of the proposal

In the project, many different measures to optimize the train operation and to upgrade the existing infrastructure have been identified. Although all the measures can contribute to energy saving and capacity increase, they need different costs for implementation and maintenance and give different levels of benefits, especially when the service life of rail infrastructure normally has a long time span. The objective of the master's thesis focuses on cost modelling and cost-benefit analysis of different identified measures, which is beneficial for decision-maker to compare the cost-effectiveness of different measures and eventually make the right decision. The study will analyze the impact of different measures and actions on Stockholm's local rail transport by quantifying the benefits and costs of different measures and activities over the lifetime. In the work, not only technical aspects but also economic issues, e.g., revenue, capital cost, depreciation, interest, energy price, etc. will be considered. Some input and previous experience from the industrial partners may be acquired. Based on the cost model, the work will make a comprehensive study of possible measures to improve the performance of the existing rail transport. In the end, some proposals for train operation and system upgrading will be made. All the work will be summarized in the thesis report and presented to industrial partners. These tasks might be updated while working on the project.

### Type of degree project (can be both)

Master (20 weeks):

Bachelor/Högskoleingenjör (10 weeks):

### Language for the thesis

Swedish:  and/or English:

### Supervisor/Contact person

William Z. Liu  
zhendong@kth.se

Supervisor

Sidharth Kapoor  
skapoor@kth.se

Co-supervisor



# Modelling Power Supply Systems of Stockholm Local Rail Transport

## Rail Vehicle Unit (In collaboration with SL and MTR)

### Background

The urban rail transport systems in Stockholm are one of the most important parts of public transport for both residents and travelers. They provide a cheap and time-efficient means of transport and help to ease congestion and pollution in urban areas. Even though the rail transport is very energy-efficient and runs on green electricity, the power supply systems of the Stockholm local rail transport are relatively old and weak, which lowers energy efficiency and limits the increase in transport capacity. The power supply systems have become bottlenecks for the development of Stockholm's local rail transport. In order to assist the development of the local rail transport, a research project on finding solutions for a more sustainable transport system (financed by Vinnova InfraSweden2030) is conducted to set up a smart and cost-effective management plan for efficiently using infrastructure as well as saving energy.

### Description of the proposal

The objective of the master's thesis focuses on modelling the electric infrastructure of the Stockholm's local rail transport. The interaction between trains and infrastructure in different operational conditions will also be modeled in the work. Sensor data from infrastructure and trains in operation may be acquired from industrial partners. Based on the model, some parameter studies will be conducted to identify the weak sections of the existing infrastructure and look for possible solutions for energy saving and capacity increasing, e.g., changes to train operation and marginal upgrades to infrastructure. In the present master's thesis, a literature study on the electric infrastructure of the power supply systems and the corresponding models will be conducted to assist the modelling work. Based on the technical input from industrial partners and recorded sensor data, the developed model will be used to explore the potential of the existing infrastructure and analyze the impact of different measures on easing the burden on the power supply systems of the infrastructure. In the end, some proposals for train operation and system upgrading will be made. All the work will be summarized in a thesis report and orally presented to Industrial partners. These tasks might be updated while working on the project. Good knowledge of Modelling in Matlab/Simulink is preferable.

### Type of degree project (can be both)

Master (20 weeks):

Bachelor/Högskoleingenjör (10 weeks):

### Language for the thesis

Swedish:  and/or English:

### Supervisor/Contact person

William Z. Liu  
zhendong@kth.se

Supervisor

Sidharth Kapoor  
skapoor@kth.se

Co-Supervisor



# Modelling Energy Usage of Maglev and Maglev Derived Systems

## Rail Vehicle Unit

### Background

Magnetic Levitation (maglev) systems are one kind of guided transport system that is levitated and propelled from the guideways by using magnetic forces. Since maglev systems do not have any contact between the moving vehicle and the guideway during operation, the operational speed is no longer limited by the adhesion at the rail-wheel interface. There is neither any rolling resistance nor any rotational component on the moving vehicle, which makes the high-speed operation safer and more energy-efficient in high-speed operation. Compared with rail transport, many technical problems can be avoided, e.g., rail-wheel wear and fatigue, noise and vibration, low adhesion etc. In the world, there are mainly two types of levitation technology: electromagnetic suspension (EMS) and electrodynamic suspension (EDS). The maglev systems are relatively new technology and have distinguished features. The maglev systems have the potential to improve the overall performance of future transportation. As the EU plans to build integrated, sustainable, multimodal transport networks for the future, in the coming EU-Rail's research and innovation program, the technical feasibility and effectiveness of the maglev systems are to be evaluated. Among other things, energy efficiency is one of the critical aspects that need to be addressed.

### Description of the proposal

Since in Europe, there is no maglev system still in operation currently, the objective of the master thesis is to review the existing technology and related studies and build an energy usage model of different maglev systems. In the thesis work, many aspects are going to be considered: different technologies, train designs, infrastructure, driving styles, etc. The impact of different parameters on energy usage will be studied. A comparison of overall energy efficiency between the existing railway systems and maglev systems will be made. The thesis work will consist of the following tasks: 1) Literature study of Electric components of maglev systems, Energy usage of different maglev systems, Modelling methods of energy usage, and Key input parameters for energy calculation; 2) Modelling the energy usage of different maglev and maglev derived systems; 3) Studying the impact of different parameters on energy usage; 4) Comparing energy efficiency of railway systems and different maglev systems; 5) Thesis writing and presenting results orally. These tasks might be updated while working on the project. Good knowledge of Modelling in Matlab/Simulink is preferable.

### Type of degree project (can be both)

Master (20 weeks):

Bachelor/Högskoleingenjör (10 weeks):

### Language for the thesis

Swedish:  and/or English:

### Supervisor/Contact person

William Z. Liu  
zhendong@kth.se

Supervisor

Sidharth Kapoor  
skapoor@kth.se

Co-Supervisor



# Improving Train Thermal Comfort for Energy Saving Based on On-site Measurement

## Rail Vehicle Unit

### Background

Energy efficiency is becoming increasingly important. Urban rail transport systems in Stockholm provide a cheap and time-efficient means of transport and help to ease congestion and pollution in urban areas. Right now, in the world all the rail traffic systems, e.g., metro, commuter train, regional train and intercity train, follow the same standard. However, the thermal comfort of local rail transport is not very good due to different seasons, climate conditions and train services. Previous studies have shown that it is possible to both improve thermal comfort and save energy. It is necessary to determine different thermal comfort level with respect to different conditions for decision-maker to make right decision.

### Description of the proposal

The thesis is a follow-up of previous work but mainly focuses on on-site measurement. Temperatures and airflow of different trains in different seasons will be measured with KTH's equipment. Train operation, passenger clothing level, occupancy rate, outdoor temperature, etc., will be also measured. Passenger's opinions towards thermal comfort is supposed to be collected during the measurements. Post-processing or the measurement results and survey results will be conducted. Based on analysis of the results, some suggestions on improving thermal comfort under different seasons and conditions will be given. All the work will be summarized in a report and orally presented. These tasks might be updated while working on the project. Good knowledge of data processing with Excel or Matlab is preferable.

### Type of degree project (can be both)

Master (20 weeks):

Bachelor/Högskoleingenjör (10 weeks):

### Language for the thesis

Swedish:  or English:

### Supervisor/Contact person

William Z. Liu  
zhendong@kth.se

Supervisor

Sidharth Kapoor  
skapoor@kth.se

Co-supervisor



# Impact of Digital Automatic Couplers in wheel damage of freight wagons

## KTH Rail Vehicles - EU Rail project with Trafikverket

### Background

In EU Rail project Trans4M-R, the introduction of Digital Automatic Couplers (DAC) in freight wagons is being studied in all the railway system dimensions, from operational benefits and migration plans to regulatory framework and standards. Some standards rely on dynamic simulations, so accurate dynamic simulation models are needed.

### Problem description, tasks, and goals

The proposal consists of a comparative study of the differences between classic screw-buffer couplers against modern central couplers, in terms of curving capabilities and wheel damage levels. The preliminary tasks are i) a literature study on DAC ii) modelling of DAC for dynamics simulations iii) implementation of a 3-wagon model with DAC couplers based on an existing model with screw couplers and iv) dynamics simulations and long-term damage simulations of both.

### Type of degree project (can be both)

Master (20 weeks):

Bachelor/Högskoleingenjör (10 weeks):

### Language for the thesis

Swedish:  and/or English:

### Is Swedish a language requirement?

Yes:

No:

No, but Swedish is a requirement for future employment:

### Possibility to work from our office

Yes:

No:

### Contact person

Carlos Casanueva  
carlosc@kth.se

Project Responsible at KTH Rail Vehicles

# Efficient wheel and rail wear evolution for railway system LCC calculations

## KTH Rail Vehicles – project in the Universal Cost Model framework

### Background

In Shift2Rail project NEXTGEAR, a framework for comparative Life Cycle Cost (LCC) studies has been developed, directed towards evaluating the introduction of innovations in the different railway subsystems and stakeholders. The KTH wear calculation method for wheels and rails is an iterative method that uses dynamic simulations in a characteristic set of curves, and then updates these profiles with the estimated wear. As the profiles influence the dynamics simulations, the process is necessarily iterative, and thus computationally inefficient.

### Problem description, tasks, and goals

The proposal consists of studying a proposal from the NEXGEAR project where the wheel and rail wear calculations in the UCM are not calculated in an iterative way but estimated with a single set of dynamics simulations and extrapolated. The disadvantage of this simplified wear calculation is that wear is localized in limited areas on the profiles, resulting in very deep local peaks. In real operation, when there is wear at a certain position, the position of the contact point moves away from this location, since contact inside a hole is not possible. In order to account for a non-iterative method that still has realistic wear rates, the proposal is to distribute the total amount of accumulated wear over the profile as it would be in reality, e.g. using profile measurements. The project would entail: i) a literature review ii) a study of different wear shapes and a proposal of possible simplifications e.g. parabolic shapes iii) a study of the pros and cons of representing the wear this way, specifically for comparing the performance of different vehicles using dynamic simulations.

### Type of degree project (can be both)

Master (20 weeks):

Bachelor/Högskoleingenjör (10 weeks):

### Language for the thesis

Swedish:  and/or English:

### Is Swedish a language requirement?

Yes:

No:

No, but Swedish is a requirement for future employment:

### Possibility to work from our office

Yes:

No:

### Contact person

Carlos Casanueva  
carlosc@kth.se

Project Responsible at KTH Rail Vehicles

# Fuel cell modelling for hydrogen train energy consumption calculations

## KTH Rail Vehicles – project in Europe’s Rail framework, Flagship Area 4 Rail4Earth

### Background

In Europe’s Rail project Rail4Earth alternative traction chains such as Hydrogen or battery trains are being studied for a more efficient use of the non-electrified network. Hydrogen trains are a demonstrated concept with lots of potential for optimisation, thus requiring accurate models for the energy storage that are coupled to the operational energy consumption. One of the main challenges is that fuel cells are typically constant load machines with a long response time, while rail vehicles can require high instantaneous loads; for handling these load peaks, fuel cells must be coupled to batteries and/or capacitors increasing the complexity of the model.

### Problem description, tasks, and goals

KTH Rail Vehicles has developed a modular train energy calculation package that includes operational scenarios, driver behaviour, and battery models, coded in Matlab/Simulink environment. The package is non-commercial and used for research and development. The main objective of the work is to create a new independent module for the simulation package where fuel cells and the necessary auxiliary systems are included. The preliminary tasks are as follows: i) literature review of fuel cell energy storage modelling; ii) selection and implementation of a fuel cell model in Matlab/Simulink; iii) simulation of partially electrified operational scenarios for code debugging and optimisation of computational times.; iv) reporting.

### Type of degree project (can be both)

Master (20 weeks):

Bachelor/Högskoleingenjör (10 weeks):

### Language for the thesis

Swedish:  and/or English:

### Is Swedish a language requirement?

Yes:

No:

No, but Swedish is a requirement for future employment:

### Possibility to work from our office

Yes:

No:

### Contact person

Carlos Casanueva  
carlosc@kth.se

KTH Rail Vehicles - [www.kth.se/profile/carlosc](http://www.kth.se/profile/carlosc)



# A coupled FEM model of mechanical-thermo-fluid: temperature prediction of rail vehicle brake disc

School of Engineering Sciences, Rail Vehicles Group

## Background

Rail vehicles are developed towards higher speed and higher axle load, requiring robust mechanical brake systems for running safety. One component of the most important mechanical brake systems is the disc brake, which converts the kinetic energy of rail vehicles into heat. A high brake disc temperature reduces the coefficient of friction between the brake disc and the brake pad, and causes high thermal stress, which, in turn, induces thermal cracks on the brake disc. To avoid these negative impacts, it is necessary to understand how friction heat is generated and dissipated.

## Description of the proposal

The objective of the master's thesis focuses on modelling the temperature of rail vehicle brake disc, which combines contact mechanics, heat transfer and fluid mechanics. Most research uses simple analytical solutions or complex commercial Finite Element Method (FEM) software to calculate the temperature of the brake disc, which lacks accuracy or is computationally heavy. Hence, we decided to develop a new model which is accurate and fast to solve. The thesis work will consist of the following tasks, 1:Literature study of how to calculate railway brake disc temperature. 2:Derive the Partial differential equation(PDE) model, combine mechanical, thermo and fluid process. •Translate the model into FEniCSx, an opensource tool with Python interfaces. 3:Compare with experimental data, and validate the model. 4:Thesis writing and presenting results orally. These tasks might be updated while working on the project. Good knowledge of FEM, numerical method, python, CFD is preferable. PhD student Yanjun Zhang has been on this project for one year and will derive the PDE model, coding with you together. You will always get strong technical support. After this thesis, you will have good knowledge of solving PDE and programming. At least one conference manuscript will be submitted. The earliest start date: today; the latest start date: January 2024; End date: depends on you.

## Type of degree project (can be both)

Master (20 weeks):

Bachelor/Högskoleingenjör (10 weeks):

## Language for the thesis

Swedish:  and/or English:

## Supervisor/Contact person

Yanjun

PhD student

yanjunzh@kth.se

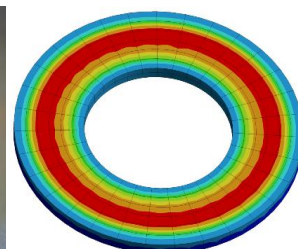

# Modelling of curved railway catenary sections for dynamic simulations

**Dep. Of Engineering Mechanics, Rail Vehicles**

## Background

The interaction between the overhead catenary lines and the vehicle's pantograph is a crucial aspect for electric railways, as it on one hand provides high-efficiency power transfer at high speed but on the other hand limits the possible operational speed in terms of dynamic compatibility. A stable and well-adjusted contact force is required to maintain reliable power transfer and to minimize maintenance efforts. To support this adjustment and to verify and improve catenary designs, simulations have become an important tool in research and engineering.

## Description of the proposal

Simulation models should depict the geometry and structure of catenary sections as accurately as possible to attain the realistic behaviour of the pantograph-catenary couple. One important example is curved track. The scope of this thesis is to:

- Study existing geometry calculation software and catenary model (Ansys APDL)
- Study Trafikverket's design standards for catenary alignment in curved track
- Implement a parametric representation of curved catenary in the FE model
- Verify the dynamic behaviour of the model in dynamic simulation

## Type of degree project (can be both)

Master (20 weeks):

Bachelor/Högskoleingenjör (10 weeks):

## Language for the thesis

Swedish:  and/or English:

## Supervisor/Contact person

Bastian SCHICK  
bschick@kth.se

PhD student

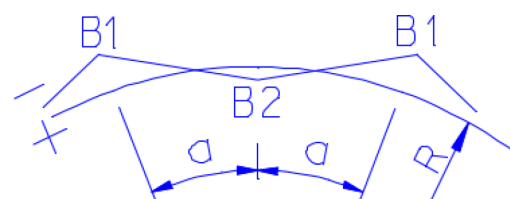
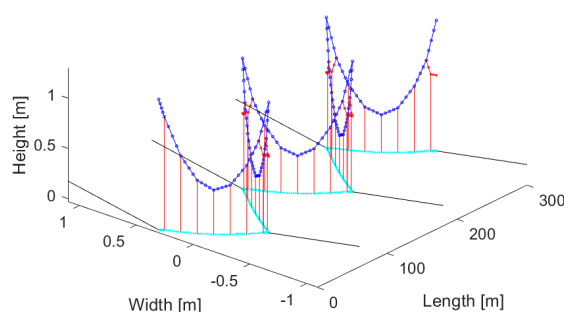

# Experimental modal analysis of a railway pantograph

Dep. Of Engineering Mechanics, Rail Vehicles

## Background

The interaction between the overhead catenary lines and the vehicle's pantograph is a crucial aspect for electric railways, as it on one hand provides high-efficiency power transfer at high speed but on the other hand limits the possible operational speed in terms of dynamic compatibility. A stable and well-adjusted contact force is required to maintain reliable power transfer and to minimize maintenance efforts. To support this adjustment and to verify and improve catenary designs, simulations have become an important tool in research and engineering. Simulation models should depict the dynamic characteristics of the pantograph as accurately as possible to attain the realistic behaviour of the pantograph-catenary couple. This usually includes expensive measurements on a specialised test rig.

## Description of the proposal

The scope of this thesis is to perform experimental structure dynamics analysis on an in-service pantograph in order to assess the possibility to acquire the dynamic characteristics of a pantograph from simplified studies that do not require a full test rig. The scope includes:

- Study existing pantograph-catenary models to understand the relevant parameters
- Design an analysis approach with the goal of acquiring these relevant parameters
- Perform the analysis on an in-service pantograph in the maintenance workshop or KTH lab
- Test the behaviour of the model with the found parameters in a dynamic simulation

## Type of degree project (can be both)

Master (20 weeks):

Bachelor/Högskoleingenjör (10 weeks):

## Language for the thesis

Swedish:  and/or English:

## Supervisor/Contact person

Bastian SCHICK  
bschick@kth.se

PhD student

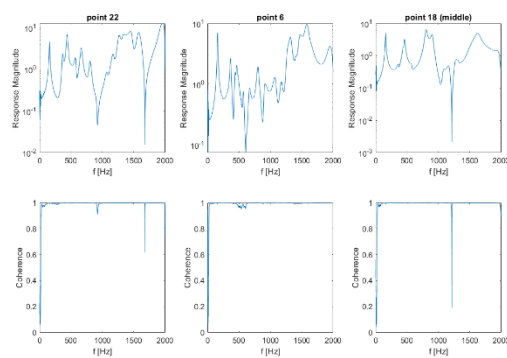
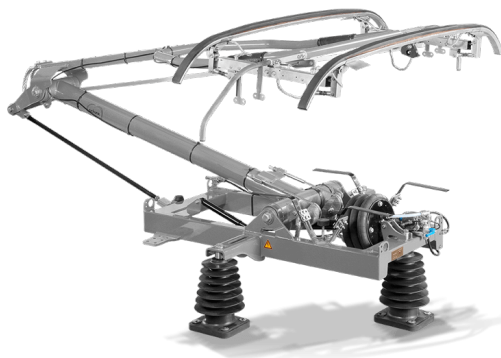



# Kartläggning av kontaktledningssystem i Sverige

## Institutionen för Teknisk Mekanik, Spårfordon

### Background

Ett bra samspel mellan kontaktledningen och tågets strömavtagare är kritisk för en fungerande elektrifierad järnväg. Den säkerställer en högeffektiv effektöverföring till tåget även vid höga hastigheter men begränsar samtidigt den största tillåtna hastigheten med hänsyn till dynamisk kompatibilitet. För ett bra samspel krävs en stabil och välanpassad kontaktkraft, vilket säkerställs genom både mätning och simulering. Simuleringar baseras från början på ideala förutsättningar, men för att komma närmare till de realistiska förhållandena behövs detaljerad information om hur anläggningen ser ut i praktiken. Sådan information kan med fördel uttryckas statistiskt.

### Description of the proposal

Syftet med arbetet är att ta fram och applicera en metod för att sammanställa en kartläggning av kontaktledningarna i det svenska järnvägsnätet. Projektet ska omfatta:

- Genomgång av Trafikverkets standarder för kontaktledningssystem i Sverige
- Sammanställning av relevanta parametrar som är relevant indata för simulering
- Utarbetning av en metod för att systematiskt sammanställa de relevanta parametrarna
- Statistisk kartläggning av kontaktledningarna i det svenska järnvägsnätet enligt metoden

### Type of degree project (can be both)

Master (20 weeks):

Bachelor/Högskoleingenjör (10 weeks):

### Language for the thesis

Swedish:  and/or English:

### Supervisor/Contact person

Bastian Schick  
bschick@kth.se

PhD student

# Load capacity assessment of stone masonry arch bridges

## Division of Structural Engineering and Bridges

### Background

There is a demand to increase the allowable axle loads for freight trains on many parts of the Swedish railway network. This often result in the need to re-assess the load capacity of existing bridges, both by inspections and calculations. There are about 100 stone masonry arch bridges in the Swedish railway network, most of them built over 100 years ago. The documentation on how the bridges were design and built is often sparse and there is a lack of a unified approach to assess the load capacity.

### Description of the proposal

Within the scope of a master thesis project the objective is to assess the load capacity of a selected set of stone masonry arch bridges in the Swedish railway network. The results will be compared by using different methods, e.g. the purpose-built software “LimitState:Ring” with general finite element models in 2D and 3D. The work will performed in collaboration with Swedish Transport Administration within an ongoing project. Data from inspections and laser scanning of the arch geometry for a case study bridge will be available.

### Type of degree project

Master (20 weeks)

### Language for the thesis

Swedish or English

### Supervisor/Contact person

Andreas Andersson  
adde@kth.se

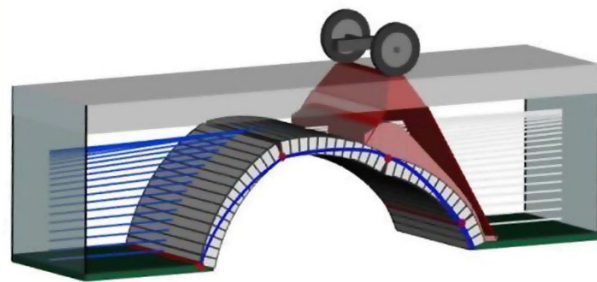

Figure 1: Left: photo of a stone masonry arch bridge for railway traffic, right: example of a computational model using the software LimitState:Ring, <https://www.limitstate.com/ring>

### References

- Andersson, A., 2011. Capacity assessment of arch bridges with backfill: Case of the old Årsta railway bridge. *PhD-thesis, KTH Bulletin 107*, <https://urn.kb.se/resolve?urn=urn:nbn:se:kth:diva-32827>
- Bjurström, H., Lasell, J., 2009. Capacity assessment of a single span arch bridge with backfill. KTH/BKN/EX-271-SE, <http://urn.kb.se/resolve?urn=urn:nbn:se:kth:diva-37023>



# Longitudinal track-bridge interaction, load transfer from braking/traction forces

## Division of Structural Engineering and Bridges

### Background

In the design and load capacity assessment of railway bridges, many load scenarios need to be checked, often as a combination of permanent and variable loads. Longitudinal loads, e.g. braking- and traction loads from the train, are distributed from the track to the bridge structure and finally to the support and adjacent track embankment. This is often performed by applying simplified loads directly to the bridge deck, neglecting the load transfer of the track. Longitudinal track-bridge interaction can be seen as a time-variant nonlinear system where the capacity is governed by the longitudinal track resistance which is different for loaded and unloaded conditions. A better description of the load transfer can potentially result in more cost-efficient design of railway bridges and assist in upgrading the load capacity of existing bridges.

### Description of the proposal

Within the scope of a master thesis project, nonlinear numerical analyses will be performed to simulate the load transfer from the track to the bridge and adjacent embankment due to variable loads, mainly braking- and traction forces but also the vertical train load and temperature variations. Experimental data from a long-term monitoring system on an existing railway bridge is available, to compare the results from simulations, mainly regarding temperature effects and passing trains. The work is a continuation of a previous master thesis project and is related to a proposed research project.

### Type of degree project

Master (20 weeks)

### Language for the thesis

English

### Supervisor/Contact person

Andreas Andersson

adde@kth.se

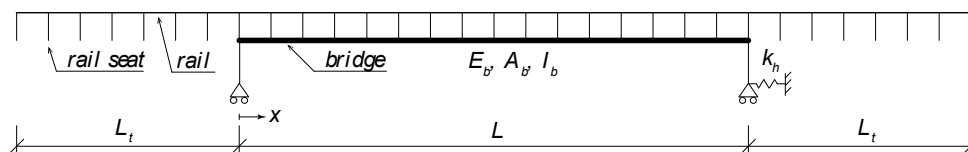

Figure 1: A typical 2D track-bridge interaction model.



Figure 2: The bridge with a long-term monitoring system.



# Onboard condition monitoring of vehicle-track dynamic interaction

## Dep. of Engineering Mechanics, Rail Vehicles unit

### Background

Condition monitoring of rail transport systems plays an ever more important role in making the maintenance more efficient and the service more reliable. Condition monitoring paves the way to move from time-based maintenance to condition-based maintenance which can enhance the reliability/availability of the system, bring down costs and increase infrastructure managers' and train operators' system condition awareness. A key area is here condition monitoring of the dynamic interaction between vehicles and tracks. Traditionally this interaction is monitored from the track, but monitoring from onboard in-service trains is growing rapidly.

### Description of the proposal

This thesis work will be carried out in close collaboration with SJ AB, the main passenger train operator in Sweden. In particular, measurement data from carbody accelerations of X2000 coaches should be used to analyse the vehicle-track interaction as the coaches run along different railway lines. Your task will also be to propose methods in the condition monitoring to detect malfunctions and defects in the system dynamics and quickly and efficiently take proper actions. The work may also include monitoring for other types of malfunctions and simulations of the dynamics (vibrations etc) at different operational conditions. Signal processing, big data analysis and machine learning are key elements in the work.

### Selection criteria

- Good record of studies
- Independent and willing to seek support from industry partners (easier if you can Swedish)
- Fast learner and problem solver
- Interested in working with Machine Learning Algorithms

### Application

- The thesis amounts to 30 hp for the second cycle (master) students
- The thesis will be registered under degree project in Rail Vehicle Engineering with number SD231X. So please check on the KTH webpage that you fulfil the requirements.
- Your application should include your CV and transcript
- Examiner: Sebastian Stichel

### Type of degree project (can be both)

Master (20 weeks):

Bachelor/Högskoleingenjör (10 weeks):

### Language for the thesis

Swedish:  and/or English:

### Supervisor/Contact person

Alireza Qazizadeh  
alirezaq@kth.se

Researcher



# Planning new sustainable rail transport – Reviving the dream of the Hudiksvall-Røros line

## KTH Division of Transport Planning

### Background

In the first half of the twentieth century, a railway connecting Hudiksvall on the Swedish east coast with Røros in Norway was repeatedly discussed, but it never happened. The connection would have consisted of the existing – but now closed – railway lines Hudiksvall-Ljusdal and Sveg-Hede and the construction of new railway lines. Today, road travel is the only alternative for tourists going to the mountains in western Härjedalen, for timber transports to sawmills at the coast, and everyone else. In light of climate change, is investing in a new railway line through a more rural area possible?

### Problem description, tasks, and goals

The exact scope of the thesis will be decided together with the student. Possible questions to investigate include: Would construction of a railway Hudiksvall- Røros be (economically, environmentally) beneficial today? Should the railway be electrified or use other solutions (diesel, battery, hydrogen)? Plan the location of the railway and its stations. Investigate the type and extent of traffic to be expected, e.g. freight, tourism, commuters, etc.

### Type of degree project (can be both)

Master (20 weeks):

Bachelor/Högskoleingenjör (10 weeks):

### Language for the thesis

Swedish:  and/or English:

### Is Swedish a language requirement?

Yes:

No:

No, but Swedish is a requirement for future employment:

### Possibility to work from our office

Yes:

No:

### Contact person

Ingrid Johansson  
injohans@kth.se

Researcher at KTH



# Traffic and timetable planning for Inlandsbanan

## KTH Division of Transport Planning

### Background

Inlandsbanan is a single-track railway line through (mostly) sparsely populated areas of northern Sweden. The yearly traffic consists of freight trains, seasonal passenger trains, and a few special event trains. One possibility to increase the traffic is if the public transport Mora-Östersund, today run by bus, is moved back to the railway, thus increasing the traffic.

### Problem description, tasks, and goals

The exact scope of the thesis will be decided together with the student. Possible issues to focus on are: How would the current bus timetable be transferred to a railway timetable if buses were replaced by trains? How much can the traffic (passenger and freight) increase on the existing infrastructure?

### Type of degree project (can be both)

Master (20 weeks):

Bachelor/Högskoleingenjör (10 weeks):

### Language for the thesis

Swedish:  and/or English:

### Is Swedish a language requirement?

Yes:

No:

No, but Swedish is a requirement for future employment:

### Possibility to work from our office

Yes:

No:

### Contact person

Ingrid Johansson  
injohans@kth.se

Researcher at KTH



# Analysing the passenger flow at Stockholm railway stations

## KTH Division of Transport Planning

### Background

Stockholm Central is a busy railway station where the platforms are accessed from two different floors, and there are multiple exits. The station is also connected to the metro system and to the commuter train station Stockholm City. When people change between the different transport modes and between platforms at the central station, especially during peak hours, it can be difficult to pass through the streams of people.

### Problem description, tasks, and goals

The exact scope of the thesis will be decided together with the student. The suggested scope is to study and analyse the flow of people walking on and between the stations Stockholm Central and Stockholm City. A pedestrian simulator could be used to investigate the movements. What are the patterns in the movement today? Are there problematic spots? Propose actions to improve mobility, if possible.

### Type of degree project (can be both)

Master (20 weeks):

Bachelor/Högskoleingenjör (10 weeks):

### Language for the thesis

Swedish:  and/or English:

### Is Swedish a language requirement?

Yes:

No:

No, but Swedish is a requirement for future employment:

### Possibility to work from our office

Yes:

No:

### Contact person

Ingrid Johansson  
injhans@kth.se

Researcher at KTH



# Rail platform allocation for easy passenger interchanges

## KTH Division of Transport Planning

### Background

The decision of which track a train should use at a station is often based on tradition or what is easiest for the dispatcher, i.e. spreading out the trains to have few crossing train paths. But the passengers instead want to have easy train changes at the same platform. The problem is how to balance these two conflicting goals.

### Problem description, tasks, and goals

The exact scope of the thesis will be decided together with the student. Possible issues are: analyse train changes at a station where the minimum desired interchange time varies depending on the platform pairs, including accurate modelling of which train pairs form a relevant passenger connection; applying some optimisation model to optimise the platform allocation; assessing the spread of delays from different platform allocations through RailSys simulation; applying a cost-benefit analysis (CBA) to weigh together impact from crossing train paths, changes at the same platform and capacity utilisation to find the best balance between the conflicting goals for different allocation scenarios.

### Type of degree project (can be both)

Master (20 weeks):

Bachelor/Högskoleingenjör (10 weeks):

### Language for the thesis

Swedish:  and/or English:

### Is Swedish a language requirement?

Yes:

No:

No, but Swedish is a requirement for future employment:

### Possibility to work from our office

Yes:

No:

### Contact person

Ingrid Johansson  
injohans@kth.se

Researcher at KTH

# Potential long-distance travel demand for Hyperloop passenger transport in Sweden



## Department of Civil and Architectural Engineering/Division of Transport Planning

### Background

In an era characterized by dynamic urbanization and escalating travel needs, the exploration of cutting-edge transportation solutions becomes paramount. Among these innovations, the Hyperloop System (HPS) emerges as a pioneering contender, poised to reshape the landscape of long-distance commuting. The HPS, advertised by Elon Musk in his Hyperloop Alpha white paper, is a new transport mode consisting of capsules propelled by electromagnetic forces in low-pressure tubes. The system is claimed to reach maximum speeds ranging between 1000 km/h and 1200 km/h, while generating less emissions and noise compared to existing high-speed modes, namely high-speed trains and jets. However, deployment of the HPS is yet to occur, and research on factors impacting its demand and adoption is still very limited!

### Description of the proposal

This master's thesis investigates the potential demand for HPS by examining passenger preferences through a stated preference choice study. The thesis is structured in three main phases. Phase 1 involves designing a survey that incorporates a stated preference choice experiment. In Phase 2, leaflets will be distributed among flight and train passengers, guiding them to the main survey to collect relevant data. Finally, Phase 3 focuses on analysing the gathered data using discrete choice modelling.

### Type of degree project (can be both)

Master (20 weeks):

Bachelor/Högskoleingenjör (10 weeks):

### Language for the thesis

Swedish:  and/or English:

### Supervisor/Contact person

Mohammad Maghrouh Zefreh  
momz@kth.se

Postdoctoral Researcher

# Metro platform crowding: why do passengers choose a specific section of the platform to board a metro train?



## Department of Civil and Architectural Engineering/Division of Transport Planning

### Background

As travel demand increases in many cities around the world, overcrowding in the public transport system is recognized as a major issue, particularly during peak periods. Demand level close to capacity leads to higher congestion levels on station platforms and inside vehicles. On-platform passenger volumes influence train dwell times and passengers waiting times, as well as headway variability and service reliability. The larger the passenger load on the platform, the longer the boarding and alighting times per passenger, which results in longer train dwell times. The passenger load, however, is not uniformly distributed among different sections of the platform. Thus, there is a need to understand public transport users' motivation for choosing a specific section of the platform to board a metro train as well as their platform choice behaviour under some real-time on-board crowding information provision.

### Description of the proposal

This master's thesis explores public transport users' motivations for choosing a specific section of the platform to board a metro train via a stated preference choice study. The thesis has three main phases. Phase 1: designing a survey containing a stated preference choice experiment. Phase 2: distributing leaflets (which will direct the passengers to the main survey) among the metro passengers to collect the data. Phase 3: analysing the collected data using discrete choice modelling.

### Type of degree project (can be both)

Master (20 weeks):

Bachelor/Högskoleingenjör (10 weeks):

### Language for the thesis

Swedish:  and/or English:

### Supervisor/Contact person

Mohammad Maghrouh Zefreh  
momz@kth.se

Postdoctoral Researcher



# Applied AI for high-speed rail demand forecasting

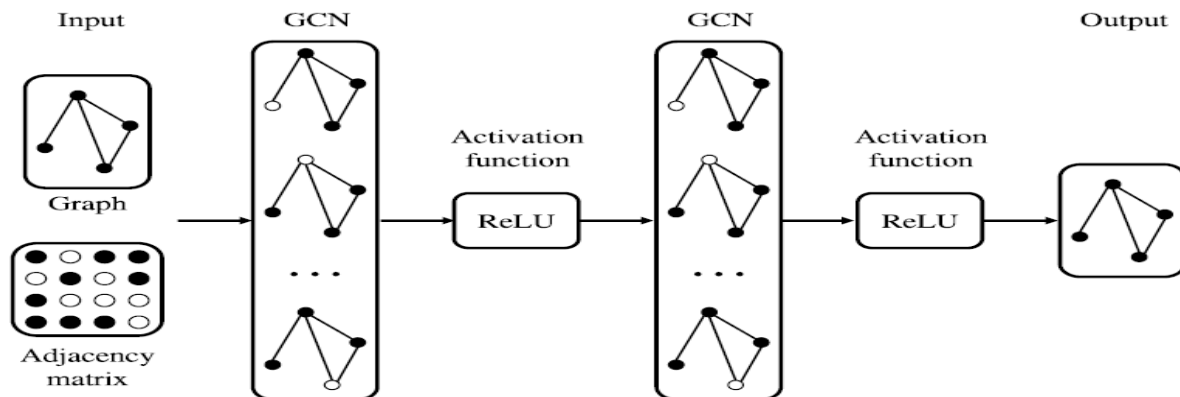

## Department of Civil and Architectural Engineering/Division of Transport Planning

### Background

The importance of long-distance rail (e.g., high-speed rail) demand forecasting cannot be overstated in the realm of strategic transportation planning. Accurate predictions of demand for long-distance rail services are instrumental in optimizing resources, improving efficiency, and enhancing overall service quality. The application of AI and deep learning (e.g., Graph Convolutional Neural Networks [GCNN]) in long-distance rail demand forecasting represents a paradigm shift in predictive modelling. By leveraging the inherent structure and interconnected relationships within rail network, GCNN excels in capturing the complex dependencies that influence rail demand over extended distances.

### Description of the proposal

This master's thesis attempts to explore the potentials of GCNN in predicting high-speed rail demand in Sweden. The thesis is structured in three main phases. Phase 1 involves literature review on the application of GCNN on demand forecasting. In Phase 2 involves data preparation, In Phase 3, various modelling frameworks (including the baseline models) will be assessed for high-speed rail demand forecasting.

**Note:** the applicant is expected to have the experience of working with Python and have a good understanding of coding and be passionate for deep learning predictions.

### Type of degree project (can be both)

Master (20 weeks):

Bachelor/Högskoleingenjör (10 weeks):

### Language for the thesis

Swedish:  and/or English:

### Supervisor/Contact person

Mohammad Maghrour Zefreh  
momz@kth.se

Postdoctoral Researcher

# Applied AI for metro delay propagation and causal discovery

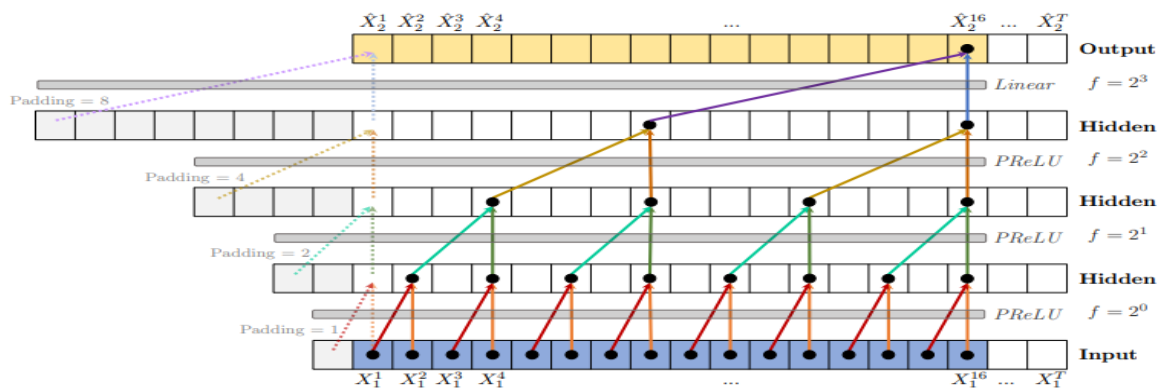

## Department of Civil and Architectural Engineering/Division of Transport Planning

### Background

The importance of metro delay causal discovery and understanding delay propagation mechanisms cannot be overstated in the realm of urban transit management. Causal discovery unveils the intricate relationships between diverse factors contributing to metro delays, unravelling the root causes behind disruptions. Simultaneously, comprehending delay propagation sheds light on how these disruptions ripple through the entire transit network, impacting subsequent services. This dual understanding is pivotal for transit authorities to adopt proactive strategies. By addressing the root causes and foreseeing how delays propagate, authorities can implement targeted solutions to mitigate disruptions, enhance system resilience, and optimize overall service reliability.

### Description of the proposal

This master's thesis aims at leveraging the applied AI to explore metro delay propagations and discover the causation of the observed delays using large-scale vehicle location data.

### Type of degree project (can be both)

Master (20 weeks):

Bachelor/Högskoleingenjör (10 weeks):

### Language for the thesis

Swedish:  and/or English:

### Supervisor/Contact person

Mohammad Maghrouh Zefreh  
momz@kth.se

Postdoctoral Researcher